

TABLES

PRICEBOOK

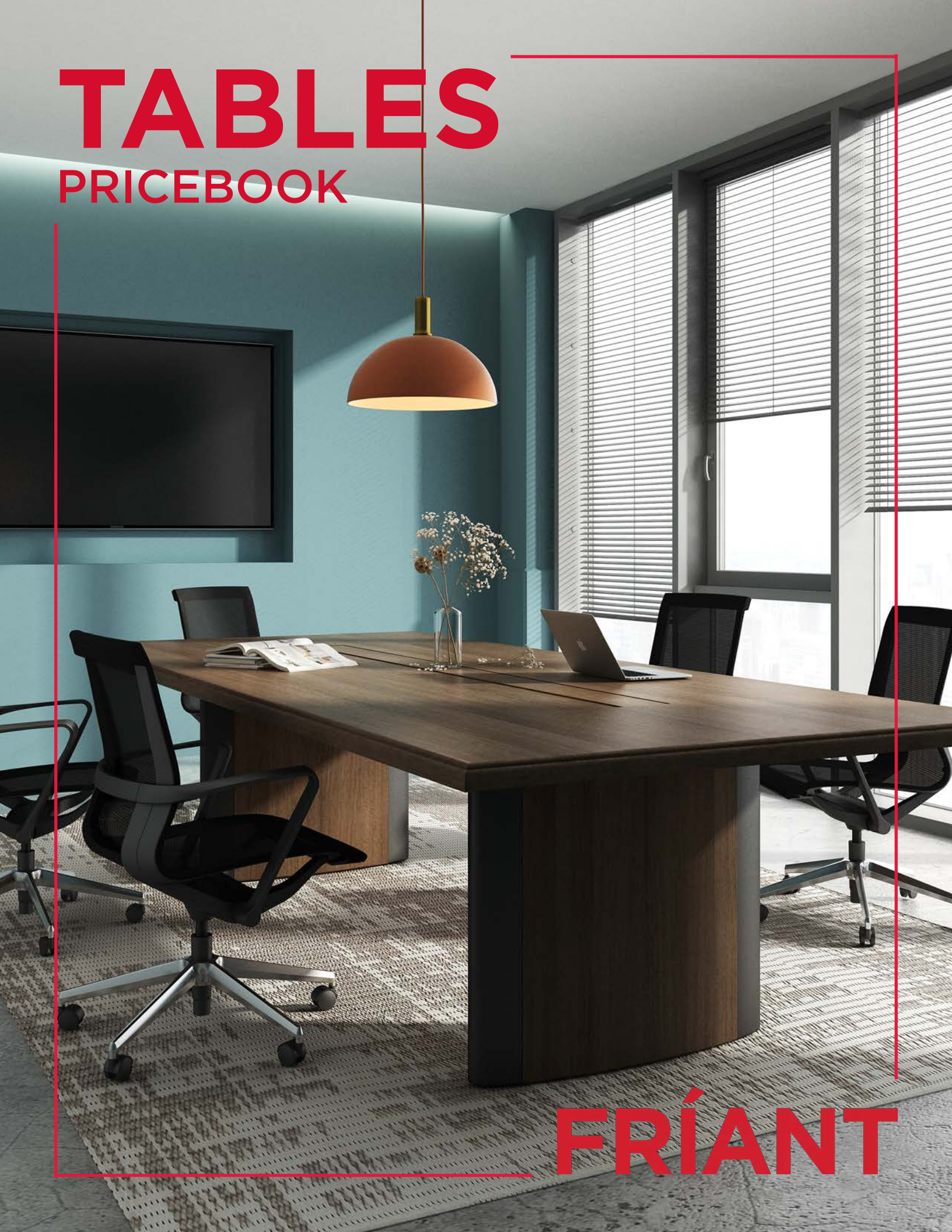

FRÍANT

TABLES

PRICEBOOK

LUNE

TRAINING TABLES

Overview	3
Pricing	8
Finishes	9

SCOPE

OCCASIONAL TABLES

Overview	11
Pricing	16
Finishes	19

MESA

CONFERENCE TABLES

Overview	21
Pricing	30
Finishes	31

TERMS & CONDITIONS	39
--------------------	----

LUNE

TRAINING TABLES

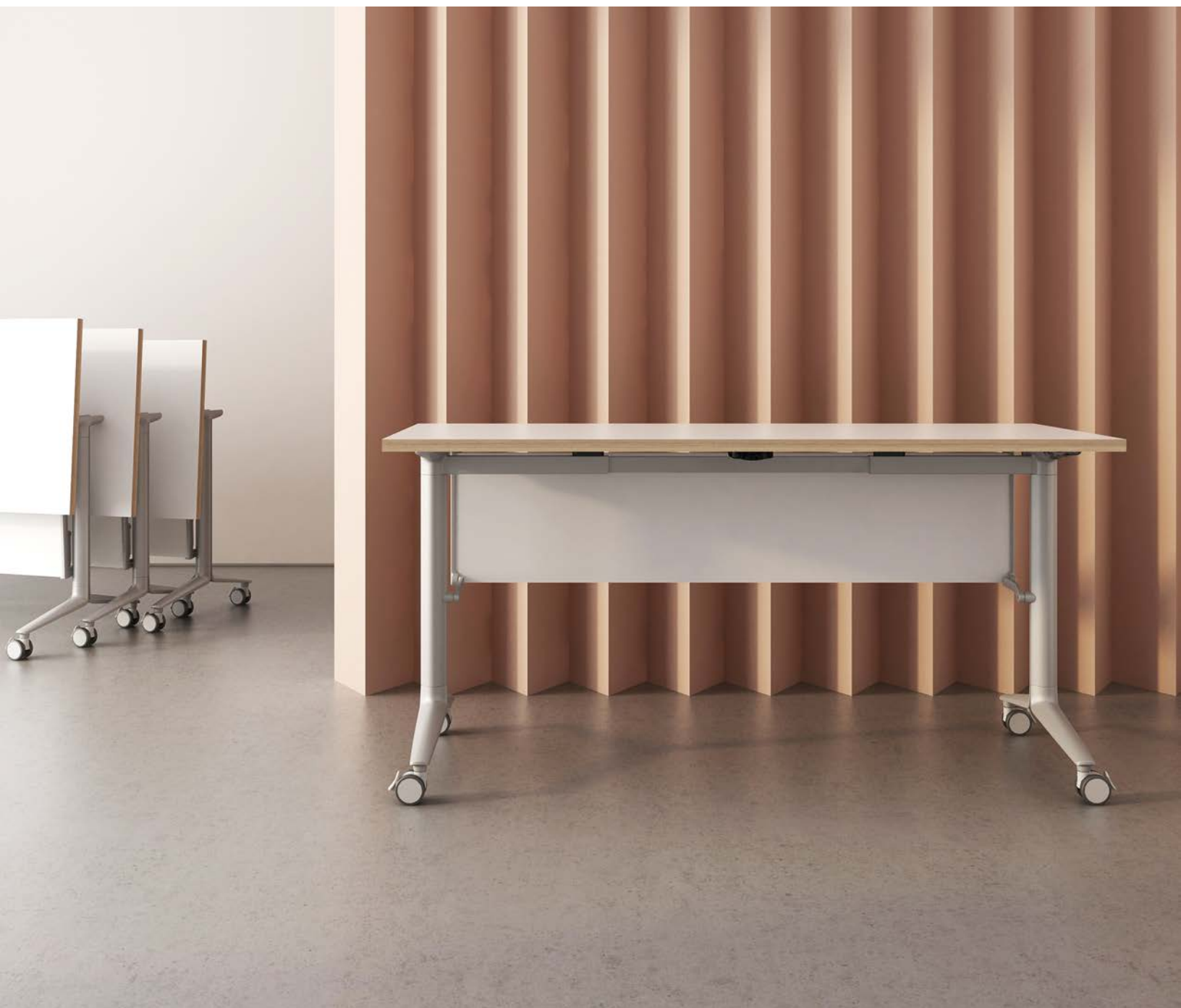



FORM
FLEXIBILITY
FUNCTION

Versatile and mobile, Lune tables are easy to set-up and configure into a wide range of spaces. Rearrange and adapt on the fly. The flip-top mechanism enables you to make the most of your space, easily nesting tables for compact storage when not in use.

TRAINING
TABLES
LUNE



Create dynamic spaces for people to learn, collaborate, and connect.

**LUNE and SOLEIL
THE PERFECT MATCH**

Soleil flip-up chairs on casters are the perfect accompaniment to Lune tables.

Find them in the Seating Catalog at friant.com

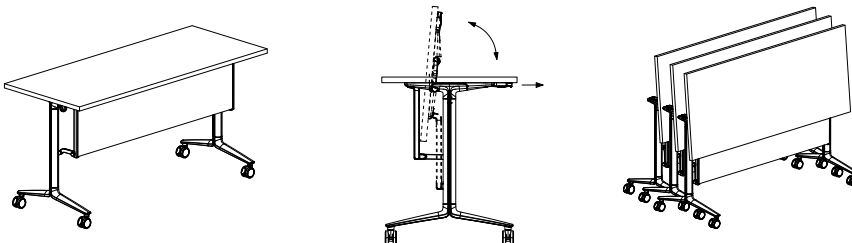

LUNE TABLE FEATURES AND FUNCTIONS

Easy to move, use and store.

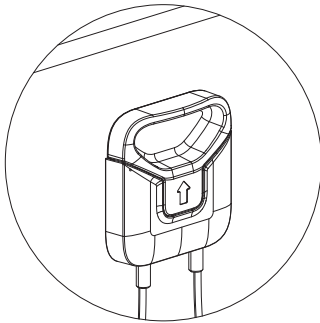

FLIP MECHANISM

Simple flip-top mechanism is designed for single-handed operation

OPTIONAL CONNECTING BRACKET

Link multiple tables together to adapt and reconfigure as needed

MODESTY PANEL

Available with and without modesty panel (on 72" tops modesty panels are required)

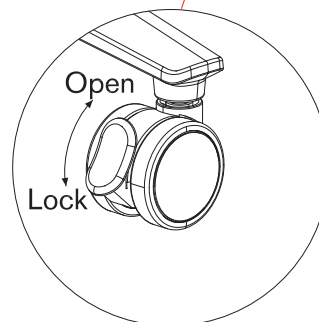
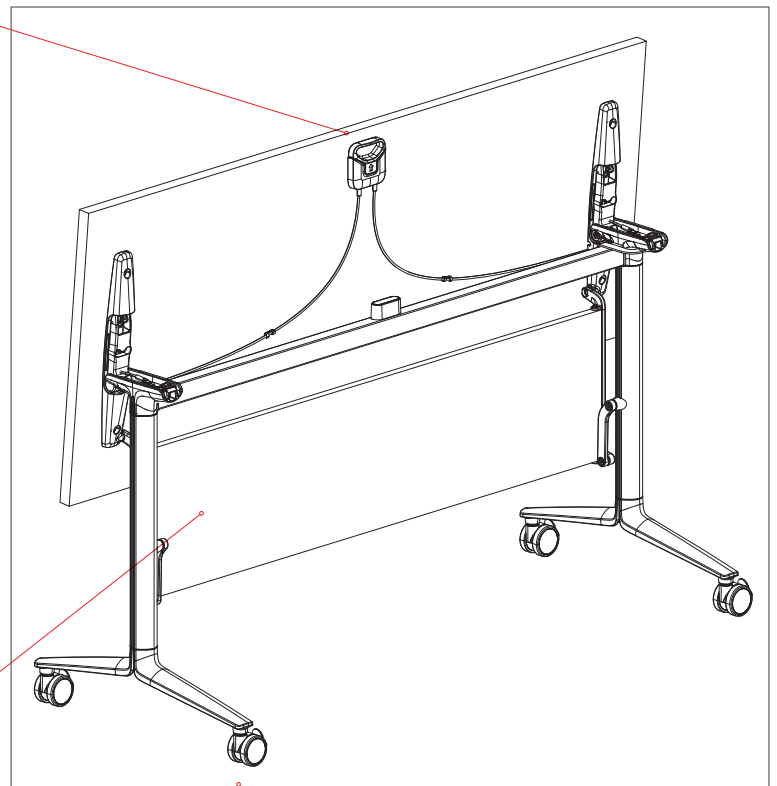

LOCKING CASTERS

Quickly and easily lock the table in place

ORDER LUNE IN 4 SIMPLE STEPS:

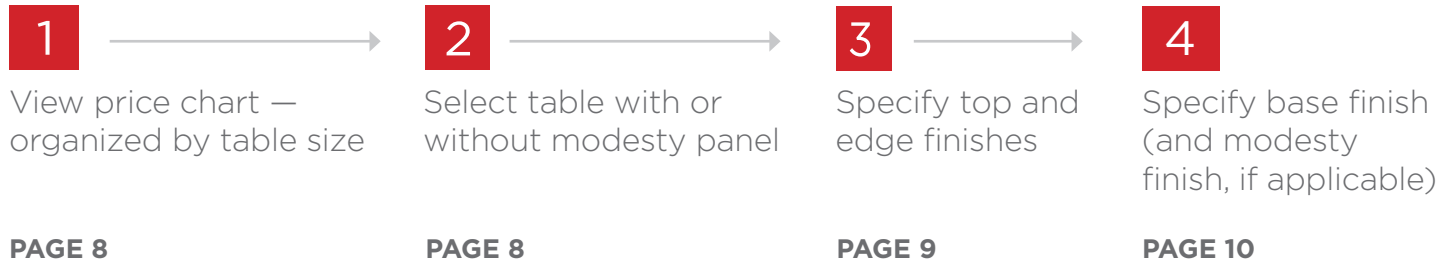

ANATOMY OF A PRODUCT NUMBER



Be sure to specify finishes and base options in the description of your order.

Example:

FCTTB-MOD.2460

Description:

Lune flip up training table on casters, with modesty panel, 24 x 60

Top Finish:	M13	Licorice
Edge Finish:	E13	Licorice
Base Finish:	GM	Gunmetal
Modesty Finish:	BU	Black Umber

LUNE TABLE WITHOUT MODESTY

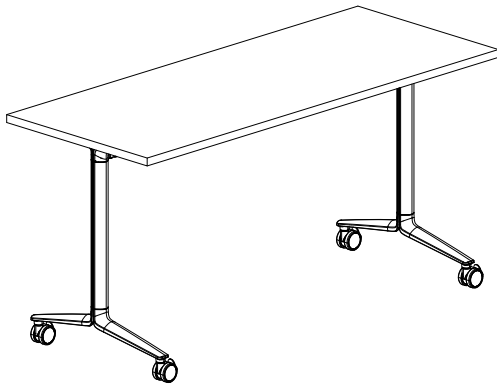

Model No.	Depth	Length	List
FCTTB.2048	20"	48"	\$1,664
FCTTB.2054	20"	54"	\$1,707
FCTTB.2060	20"	60"	\$1,711
FCTTB.2448	24"	48"	\$1,698
FCTTB.2454	24"	54"	\$1,741
FCTTB.2460	24"	60"	\$1,746
FCTTB.3048	30"	48"	\$1,707
FCTTB.3054	30"	54"	\$1,756
FCTTB.3060	30"	60"	\$1,761

LUNE TABLE WITH MODESTY

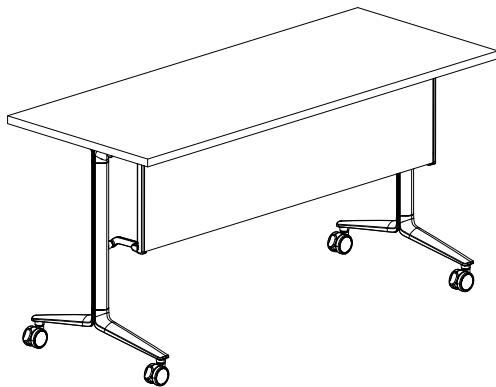

Model No.	Depth	Length	List
FCTTB-MOD.2048	20"	48"	\$1,953
FCTTB-MOD.2054	20"	54"	\$1,998
FCTTB-MOD.2060	20"	60"	\$2,001
FCTTB-MOD.2072	20"	72"	\$2,085
FCTTB-MOD.2448	24"	48"	\$1,989
FCTTB-MOD.2454	24"	54"	\$2,032
FCTTB-MOD.2460	24"	60"	\$2,035
FCTTB-MOD.2472	24"	72"	\$2,119
FCTTB-MOD.3048	30"	48"	\$1,998
FCTTB-MOD.3054	30"	54"	\$2,048
FCTTB-MOD.3060	30"	60"	\$2,053
FCTTB-MOD.3072	30"	72"	\$2,137

CONNECTING BRACKET PAIR

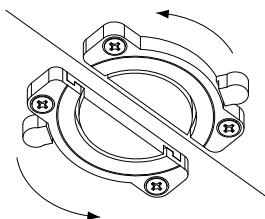











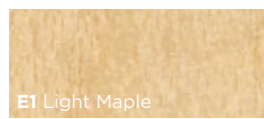

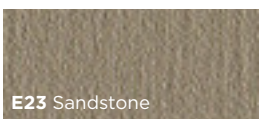
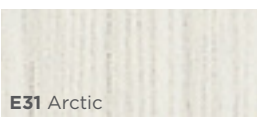
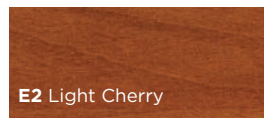
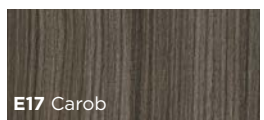
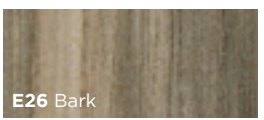

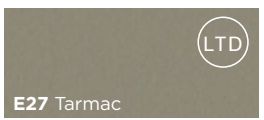
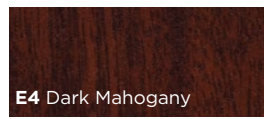

Model No.	Depth	Length	List
FCTTCB	-	-	\$41

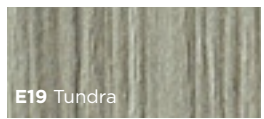
LUNE STANDARD FINISHES

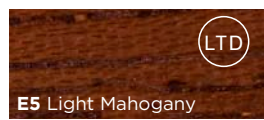
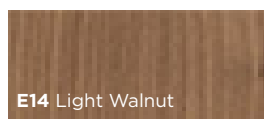
Top Finish

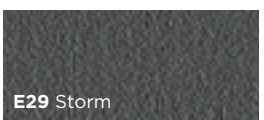
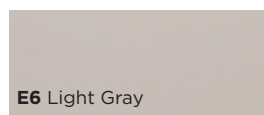
 M1 Light Maple	 M7 Off White (LTD)	 M13 Licorice	 M20 Sandstone	 M28 Arctic
 M2 Light Cherry	 M8 Gray Specs (LTD)	 M14 Carob	 M23 Bark	 M29 Raven
 M3 Medium Cherry	 M9 Cloud White	 M15 Mousse (LTD)	 M24 Tarmac (LTD)	
 M4 Dark Mahogany	 M10 Espresso	 M16 Tundra	 M25 Winter	
 M5 Light Mahogany (LTD)	 M11 Light Walnut	 M18 Capitan	 M26 Storm	
 M6 Light Gray	 M12 Medium Walnut	 M19 Fog	 M27 Medium Ash	

Edge Finish (PVC)

 E1 Light Maple	 E7 Off White (LTD)	 E13 Licorice	 E23 Sandstone	 E31 Arctic
 E2 Light Cherry	See additional edge finish colors	 E17 Carob	 E26 Bark	 E32 Raven
 E3 Medium Cherry	 E9 Cloud White	 E18 Mousse (LTD)	 E27 Tarmac (LTD)	<div style="border: 1px solid black; padding: 5px;"> <p>Additional Edge Finishes</p> <div style="background-color: #808080; height: 20px; margin-bottom: 5px;"></div> <p>E11 Medium Tone</p> <div style="background-color: #404040; height: 20px; margin-bottom: 5px;"></div> <p>E12 Dark Tone</p> </div>
 E4 Dark Mahogany	 E10 Espresso	 E19 Tundra	 E28 Winter	
 E5 Light Mahogany (LTD)	 E14 Light Walnut	 E21 Capitan	 E29 Storm	
 E6 Light Gray	 E15 Medium Walnut	 E22 Fog	 E30 Medium Ash	

 Laminate is scheduled for discontinuation when inventory is exhausted. Please contact Customer Service for current stock levels.

LUNE STANDARD FINISHES

Base Finish

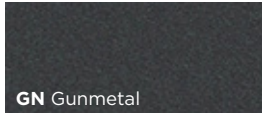

Modesty Finish

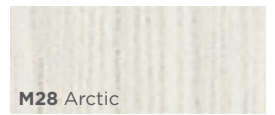
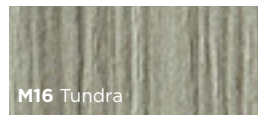
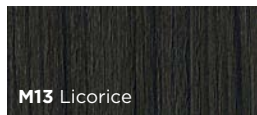
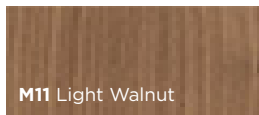

SCOPE

OCCASIONAL TABLES





FIND THE PERFECT FIT

With four heights and a wide range of shapes and sizes, these tables are ready to be where you need to be. Paired with Friant's range of stools and soft seating, it's easy to create a lounge area, meeting space, cafe space, and more.

OCCASIONAL
TABLES
SCOPE



Create spaces beyond the workstation that can foster connectivity or focus



SCOPE OCCASIONAL TABLE FEATURES

Ready to be where you want to be

SIZES AND SHAPES

Surface shapes and sizes to fit your needs, whether you're feeling square or thinking outside the box.

COLUMN HEIGHTS

Tubular steel column is offered in four different height options: lounge, table, counter, and bar

DISC BASE

Low profile weighted base for stability



THE COMPLETE PACKAGE

Friant offers stools and chairs in complementary heights to complete your space. See the options in our Seating Catalog at friant.com

SPECIFYING
OCCASIONAL
SCOPE

ORDERING IS EASY! 3 SIMPLE STEPS:

1



Select shape, size and height of table

STARTING ON PAGE 16

2



Specify top and edge finishes

PAGE 19

3

Specify base finish

PAGE 20

ANATOMY OF A PRODUCT NUMBER

FCTD-SQ37.30

MODEL NO.

TOP SHAPE

TABLE HEIGHT

TOP SIZE

Be sure to specify finishes and base options in the description of your order.

Example:

FCTD-SQ37.30

Description:

Disc Base Table, 37"H, 30" Square Top

Top Finish:	M13	Licorice
Edge Finish:	E13	Licorice
Base Finish:	MB	Matte Black

LOUNGE HEIGHT, 19”H

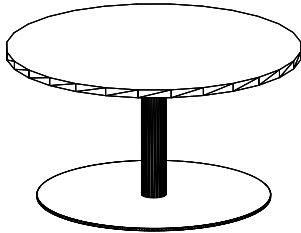

ROUND

Model No.	Top Size	List	
		Matte Black Base	Metal Base
FCTD-RD19.24	24"	\$1,145	\$1,335
FCTD-RD19.30	30"	\$1,500	\$1,690
FCTD-RD19.36	36"	\$1,811	\$2,001
FCTD-RD19.42	42"	\$1,816	\$2,006

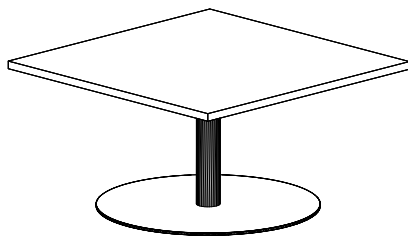

SQUARE

Model No.	Top Size	List	
		Matte Black Base	Metal Base
FCTD-SQ19.24	24"	\$1,103	\$1,293
FCTD-SQ19.30	30"	\$1,479	\$1,669
FCTD-SQ19.36	36"	\$1,772	\$1,962
FCTD-SQ19.42	42"	\$1,778	\$1,968

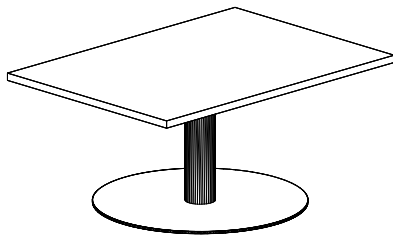

RECTANGULAR

SINGLE DISC BASE

Model No.	Top Size	List	
		Matte Black Base	Metal Base
FCTD-RT19.3042	30"x42"	\$1,531	\$1,721
FCTD-RT19.3048	30"x48"	\$1,535	\$1,725

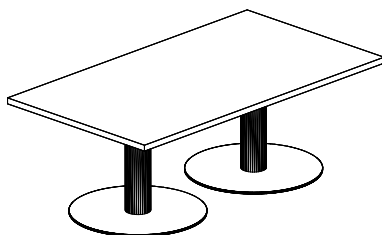

TWO DISC BASE

Model No.	Top Size	List	
		Matte Black Base	Metal Base
FCTD-RT19.3054	30"x54"	\$1,859	\$2,049
FCTD-RT19.3060	30"x60"	\$1,864	\$2,054

TABLE HEIGHT, 29”H

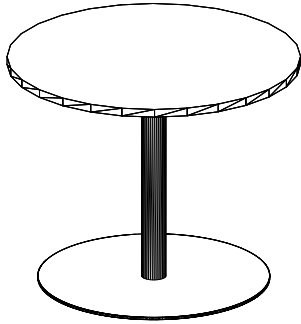

ROUND

Model No.	Top Size	List	
		Matte Black Base	Metal Base
FCTD-RD29.24	24"	\$1,155	\$1,345
FCTD-RD29.30	30"	\$1,510	\$1,700
FCTD-RD29.36	36"	\$1,821	\$2,011

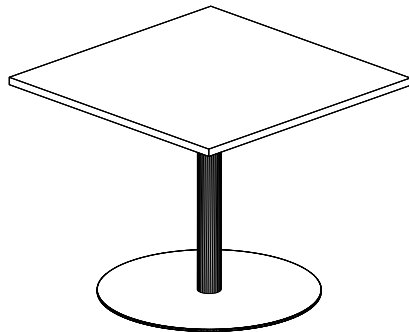

SQUARE

Model No.	Top Size	List	
		Matte Black Base	Metal Base
FCTD-SQ29.24	24"	\$1,113	\$1,303
FCTD-SQ29.30	30"	\$1,489	\$1,679
FCTD-SQ29.36	36"	\$1,782	\$1,972

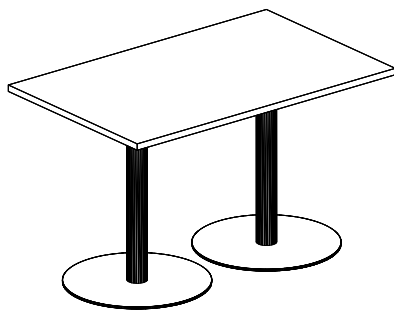

RECTANGULAR

TWO DISC BASE

Model No.	Top Size	List	
		Matte Black Base	Metal Base
FCTD-RT29.3048	30"x48"	\$1,713	\$1,903
FCTD-RT29.3054	30"x54"	\$1,812	\$2,002
FCTD-RT29.3060	30"x60"	\$1,817	\$2,007

COUNTER HEIGHT, 37”H

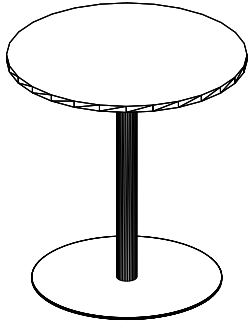

ROUND

Model No.	Top Size	List	
		Matte Black Base	Metal Base
FCTD-RD37.24	24"	\$1,183	\$1,373
FCTD-RD37.30	30"	\$1,537	\$1,727
FCTD-RD37.36	36"	\$1,849	\$2,039

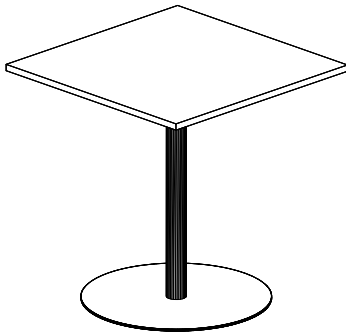

SQUARE

Model No.	Top Size	List	
		Matte Black Base	Metal Base
FCTD-SQ37.24	24"	\$1,141	\$1,331
FCTD-SQ37.30	30"	\$1,516	\$1,706
FCTD-SQ37.36	36"	\$1,810	\$2,000

BAR HEIGHT, 42”H

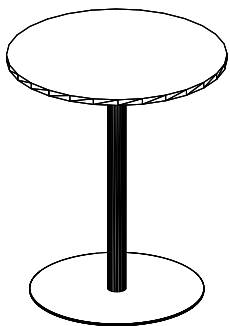

ROUND

Model No.	Top Size	List	
		Matte Black Base	Metal Base
FCTD-RD42.24	24"	\$1,191	\$1,381
FCTD-RD42.30	30"	\$1,545	\$1,735
FCTD-RD42.36	36"	\$1,856	\$2,046

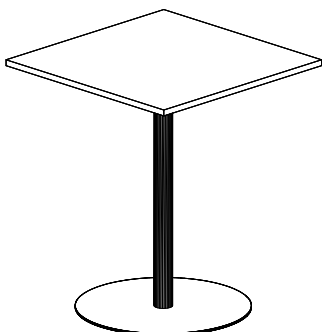

SQUARE











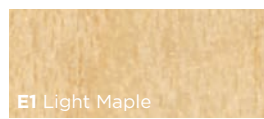

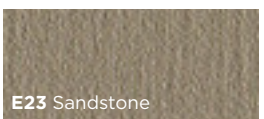
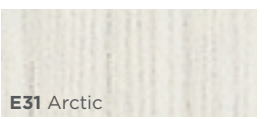
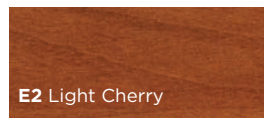
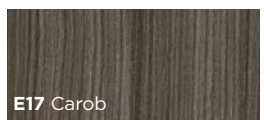
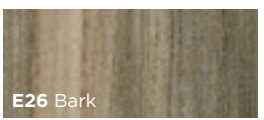

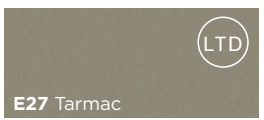
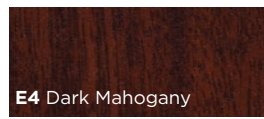

Model No.	Top Size	List	
		Matte Black Base	Metal Base
FCTD-SQ42.24	24"	\$1,149	\$1,339
FCTD-SQ42.30	30"	\$1,524	\$1,714
FCTD-SQ42.36	36"	\$1,817	\$2,007

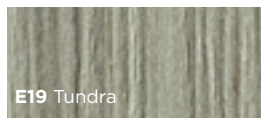
SCOPE STANDARD FINISHES

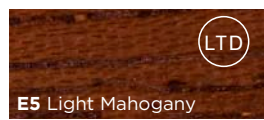
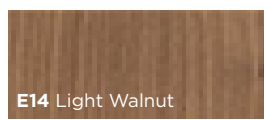
Top Finish

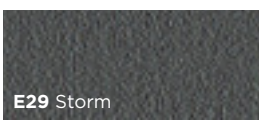
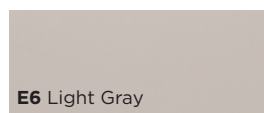
 M1 Light Maple	 M7 Off White (LTD)	 M13 Licorice	 M20 Sandstone	 M28 Arctic
 M2 Light Cherry	 M8 Gray Specs (LTD)	 M14 Carob	 M23 Bark	 M29 Raven
 M3 Medium Cherry	 M9 Cloud White	 M15 Mousse (LTD)	 M24 Tarmac (LTD)	
 M4 Dark Mahogany	 M10 Espresso	 M16 Tundra	 M25 Winter	
 M5 Light Mahogany (LTD)	 M11 Light Walnut	 M18 Capitan	 M26 Storm	
 M6 Light Gray	 M12 Medium Walnut	 M19 Fog	 M27 Medium Ash	

Edge Finish (PVC)

 E1 Light Maple	 E7 Off White (LTD)	 E13 Licorice	 E23 Sandstone	 E31 Arctic
 E2 Light Cherry	See additional edge finish colors	 E17 Carob	 E26 Bark	 E32 Raven
 E3 Medium Cherry	 E9 Cloud White	 E18 Mousse (LTD)	 E27 Tarmac (LTD)	<div style="border: 1px solid black; padding: 5px;"> <p>Additional Edge Finishes</p> <div style="background-color: #808080; height: 20px; margin-bottom: 5px;"></div> <p>E11 Medium Tone</p> <div style="background-color: #404040; height: 20px; margin-bottom: 5px;"></div> <p>E12 Dark Tone</p> </div>
 E4 Dark Mahogany	 E10 Espresso	 E19 Tundra	 E28 Winter	
 E5 Light Mahogany (LTD)	 E14 Light Walnut	 E21 Capitan	 E29 Storm	
 E6 Light Gray	 E15 Medium Walnut	 E22 Fog	 E30 Medium Ash	

 Laminate is scheduled for discontinuation when inventory is exhausted. Please contact Customer Service for current stock levels.

SCOPE STANDARD FINISHES

Base Finish

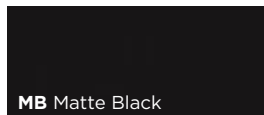

MESA

CONFERENCE TABLES





THE ULTIMATE IN PLUG & PLAY CONFERENCING

Meeting set up has never been simpler. Friant's innovative inset trough holds voice, data, and electrical outlets that keep cables organized and out of sight for an uncluttered surface conducive to focus and planning. The trough has a brushed opening and the capacity for enough voice/data and electrical wiring to power up each seat at the table. Additional cable storage space in bases.



Beneath Mesa's beauty is an ingenious design — power trough and bases that store and organize cables for a complete plug and play experience



Trough Intelligence

Friant's innovative trough organizes voice, data, and electrical cables with separate raceways for power and data.

Custom without cost

With three table shapes, a dozen edge finishes and multiple base finish options, each Mesa table can be designed with a unique aesthetic. Mesa marries beauty and functionality while remaining at a competitive price point.

CASEGOODS
CONFERENCE
MESA



Cables have two entry points to the power and data ports — through the top doors and the base columns with detachable covers. Open channel in the base also holds cables and wires.

Mesa makes connectivity easy with IT access integral to its design.

VOICE & DATA

Separate channels for voice and data keeps the cable area organized

Voice/data jacks and wiring not included.

POWER

Power capacity matches table seating, so each person at the table has a power and data outlet.

example:

An 8 ft. table has 8 outlets, a 12 ft. table has 12 outlets, etc.

Power strips are single circuit soft wire style plug-in.

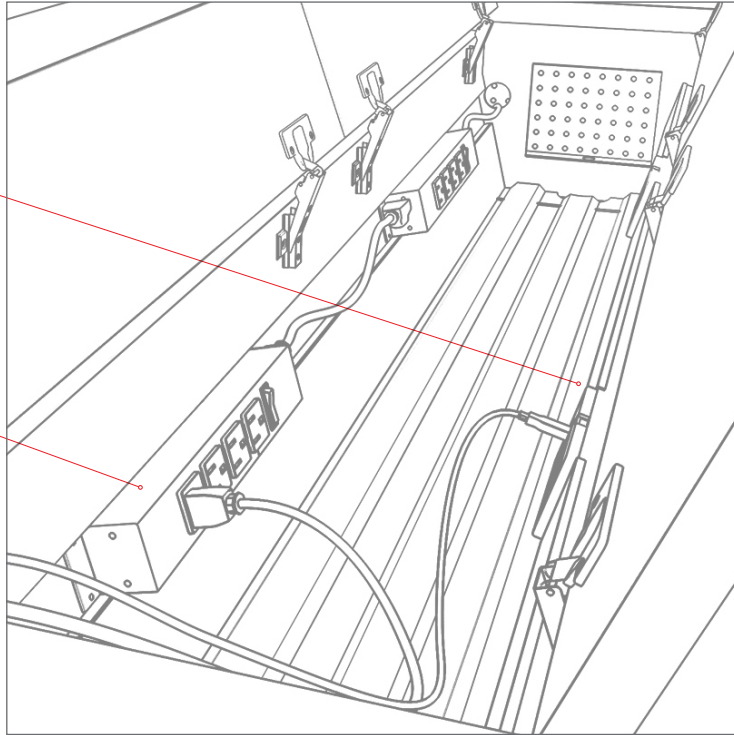

For dimensions, see page 38





Mesa is as environmentally sound as it is innovative, with materials that offer air quality assurance and LEED point contributions for recycled content

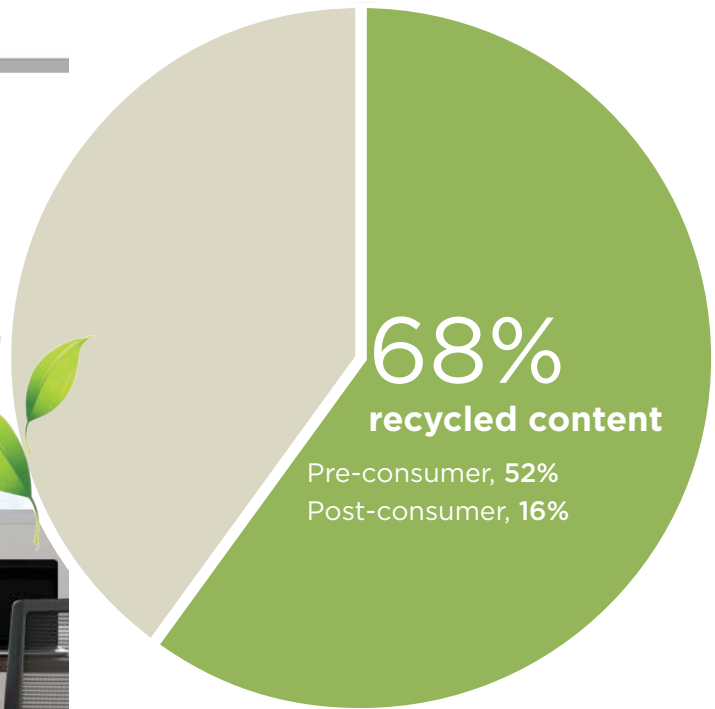

*LEED point contributions will vary according to table specifications; this chart references the table shown on page 26

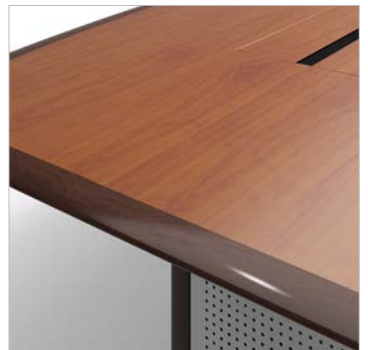

ORDERING MESA IS EASY! 4 SIMPLE STEPS:

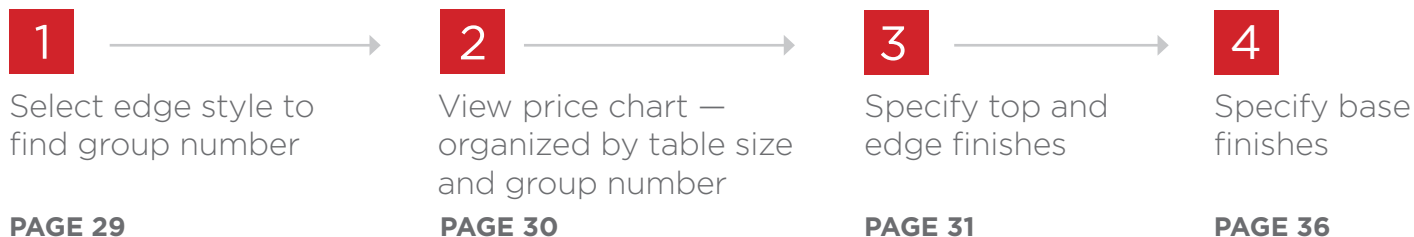

ANATOMY OF A PRODUCT NUMBER

MTB-BT-3648240-10-K

MODEL NO.

EDGE GROUP

EDGE STYLE

Model numbers are found in the pricing table on page 30. Add the edge group and style to create the complete product number for your Mesa table.

Be sure to specify finishes and base options in the description of your order.

Example:

MTB-BT-3648240-10-K

Description:

Mesa Table, Boatshaped, 36 x 48 x 240, Style Group 10, Edge Style K

Top Finish:	VNO1	American Cherry
Edge Finish:	ED01	American Cherry
Base Inset Finish:	MT01	Clouds
Base Column Finish:	VPOL	American Cherry

American Cherry top and edge, with Clouds base inset and American Cherry base columns

1 SELECT STYLE GROUP

Your choice of top and edge material determines your edge style options.



Laminate (self) edge PVC edge

Group 1

Laminate top with laminate or PVC edge



Group 9

Laminate top with solid wood edge



Group 10

Veneer top with solid wood edge



Group 11

Metal top with solid wood edge

Available Edge Styles: A & B



A 3 mm PVC B Self Edge

Available Edge Styles: J, K, J, M, N, P, Q



J Radius



K Bevel



L Beaded



M Knife



N Reverse Knife



P Double Radius



Q Bullnose

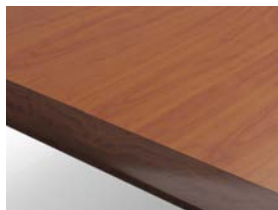

Group 12

Laminate top with solid wood edge



Group 13

Veneer top with solid wood edge

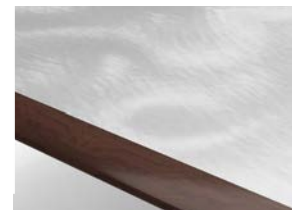

Group 14

Metal top with solid wood edge

Available Edge Styles: S, T, W



S Ellipse 2.5"



T Ellipse 3.5"



W Ellipse 4.5"

2 FIND STYLE GROUP PRICING

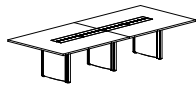

Rectangle Table



Racetrack Table

Size	Model No.	Model No.	Group 1	Group 9	Group 10	Group 11	Group 12	Group 13	Group 14
4' x 8'	MTB-RE-4896	MTB-RT-4896	\$10,703	\$16,590	\$18,194	\$20,628	\$21,407	\$23,548	\$25,980
4' x 9'	MTB-RE-48108	MTB-RT-48108	\$11,726	\$18,176	\$19,934	\$22,976	\$23,453	\$25,799	\$28,840
4' x 10'	MTB-RE-48120	MTB-RT-48120	\$13,974	\$21,661	\$23,756	\$26,797	\$27,950	\$30,744	\$33,786
4' x 11'	MTB-RE-48132	MTB-RT-48132	\$16,343	\$25,331	\$27,781	\$32,647	\$32,684	\$35,954	\$40,819
4' x 12'	MTB-RE-48144	MTB-RT-48144	\$16,978	\$26,315	\$28,861	\$33,726	\$33,955	\$37,350	\$42,215
4' x 14'	MTB-RE-48168	MTB-RT-48168	\$19,531	\$30,276	\$33,205	\$38,071	\$39,065	\$42,971	\$47,837
4' x 16'	MTB-RE-48192	MTB-RT-48192	\$20,521	\$31,807	\$34,885	\$42,182	\$41,041	\$45,146	\$52,444
4' x 18'	MTB-RE-48216	MTB-RT-48216	\$24,715	\$38,310	\$42,017	\$49,315	\$49,432	\$54,376	\$61,673
4' x 20'	MTB-RE-48240	MTB-RT-48240	\$25,862	\$40,086	\$43,968	\$51,262	\$51,725	\$56,898	\$64,195
4' x 22'	MTB-RE-48264	MTB-RT-48264	\$28,082	\$43,500	\$47,741	\$55,040	\$56,165	\$61,783	\$69,080
5' x 10'	MTB-RE-60120	MTB-RT-60120	\$16,673	\$25,842	\$28,342	N/A	\$33,343	\$36,678	N/A
5' x 12'	MTB-RE-60144	MTB-RT-60144	\$19,614	\$30,401	\$33,343	N/A	\$39,228	\$43,151	N/A
5' x 14'	MTB-RE-60168	MTB-RT-60168	\$21,662	\$33,576	\$33,582	N/A	\$43,324	\$47,658	N/A
5' x 16'	MTB-RE-60192	MTB-RT-60192	\$23,664	\$36,680	\$40,230	N/A	\$47,330	\$52,061	N/A
5' x 18'	MTB-RE-60216	MTB-RT-60216	\$28,234	\$43,762	\$47,999	N/A	\$56,467	\$62,112	N/A
5' x 20'	MTB-RE-60240	MTB-RT-60240	\$30,394	\$47,110	\$51,668	N/A	\$55,920	\$66,865	N/A
5' x 22'	MTB-RE-60264	MTB-RT-60264	\$32,107	\$49,765	\$54,582	N/A	\$64,216	\$70,636	N/A

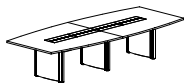









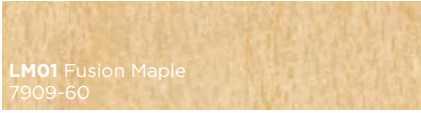
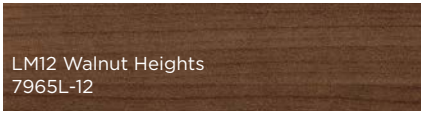
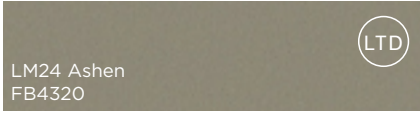
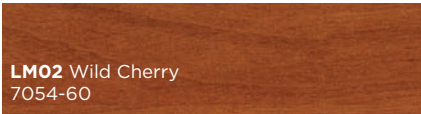
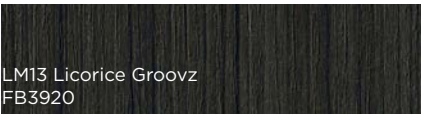

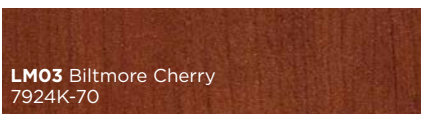

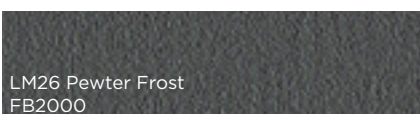
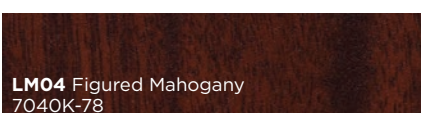

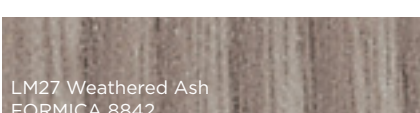
Boatshape Table

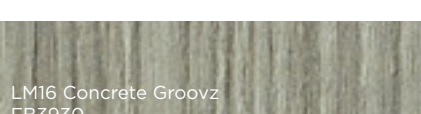
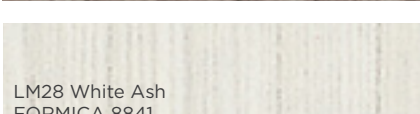
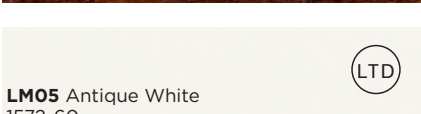
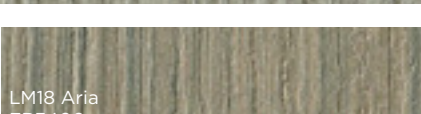
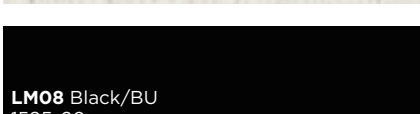
Size	Model No.	Group 1	Group 9	Group 10	Group 11	Group 12	Group 13	Group 14
3' x 4' x 8'	MTB-BT-364896	\$10,703	\$16,590	\$18,194	\$20,628	\$21,407	\$23,548	\$25,980
3' x 4' x 9'	MTB-BT-3648108	\$11,726	\$18,176	\$19,934	\$22,976	\$23,453	\$25,799	\$28,840
3' x 4' x 10'	MTB-BT-3648120	\$13,974	\$21,661	\$23,756	\$26,797	\$27,950	\$30,744	\$33,786
3' x 4' x 11'	MTB-BT-3648132	\$16,343	\$25,331	\$27,781	\$32,647	\$32,684	\$35,954	\$40,819
3' x 4' x 12'	MTB-BT-3648144	\$16,978	\$26,315	\$28,861	\$33,726	\$33,955	\$37,350	\$42,215
3' x 4' x 14'	MTB-BT-3648168	\$19,531	\$30,276	\$33,205	\$38,071	\$39,065	\$42,971	\$47,837
3' x 4' x 16'	MTB-BT-3648192	\$20,521	\$31,807	\$34,885	\$42,182	\$41,041	\$45,146	\$52,444
3' x 4' x 18'	MTB-BT-3648216	\$24,715	\$38,310	\$42,017	\$49,315	\$49,432	\$54,376	\$61,673
3' x 4' x 20'	MTB-BT-3648240	\$25,862	\$40,086	\$43,968	\$51,262	\$51,725	\$56,898	\$64,195
3' x 4' x 22'	MTB-BT-3648264	\$28,082	\$43,529	\$47,741	\$55,040	\$56,165	\$61,783	\$69,080
4' x 5' x 10'	MTB-BT-4860120	\$16,673	\$25,842	\$28,342	N/A	\$33,343	\$36,678	N/A
4' x 5' x 12'	MTB-BT-4860144	\$19,614	\$30,401	\$33,343	N/A	\$39,228	\$43,151	N/A
4' x 5' x 14'	MTB-BT-4860168	\$21,662	\$33,576	\$36,826	N/A	\$43,324	\$47,658	N/A
4' x 5' x 16'	MTB-BT-4860192	\$23,664	\$36,680	\$40,230	N/A	\$47,330	\$52,061	N/A
4' x 5' x 18'	MTB-BT-4860216	\$28,234	\$43,762	\$47,999	N/A	\$56,467	\$62,112	N/A
4' x 5' x 20'	MTB-BT-4860240	\$30,394	\$47,110	\$51,668	N/A	\$60,785	\$66,865	N/A
4' x 5' x 22'	MTB-BT-4860264	\$32,107	\$49,765	\$54,582	N/A	\$64,216	\$70,636	N/A

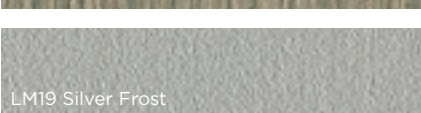
3 SELECT FINISHES: TOP

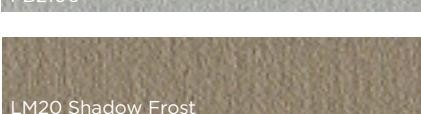
Table top finish choices includes laminate, veneer or metal. See chart below

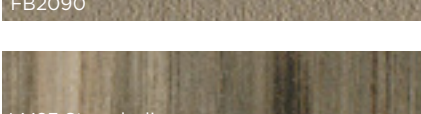
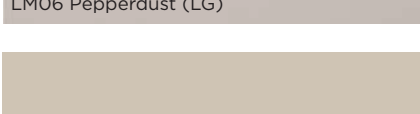
LAMINATES Edge Groups 1,9 & 12		
 <p>LM01 Fusion Maple 7909-60</p>	 <p>LM12 Walnut Heights 7965L-12</p>	 <p>LM24 Ashen FB4320</p>
 <p>LM02 Wild Cherry 7054-60</p>	 <p>LM13 Licorice Groovz FB3920</p>	 <p>LM25 Fog Grey FB2130</p>
 <p>LM03 Biltmore Cherry 7924K-70</p>	 <p>LM14 Driftwood FB3560</p>	 <p>LM26 Pewter Frost FB2000</p>
 <p>LM04 Figured Mahogany 7040K-78</p>	 <p>LM15 Mochatini FB2960</p>	 <p>LM27 Weathered Ash FORMICA 8842</p>
 <p>LM29 Windsor Mahogany 7039K-78</p>	 <p>LM16 Concrete Groovz FB3930</p>	 <p>LM28 White Ash FORMICA 8841</p>
 <p>LM05 Antique White 1572-60</p>	 <p>LM18 Aria FB3400</p>	 <p>LM08 Black/BU 1595-60</p>
 <p>LM09 Frosty White/CW 1573-60</p>	 <p>LM19 Silver Frost FB2100</p>	 <p>LM07 Slate Grey (MT) D91-60</p>
 <p>LM10 Cafelle 7933K-07</p>	 <p>LM20 Shadow Frost FB2090</p>	 <p>LM06 Pepperdust (LG)</p>
 <p>LM11 River Cherry 7937-60</p>	 <p>LM23 Stromboli FB3970</p>	 <p>LMNS Custom</p>

LTD Laminate is scheduled for discontinuation when inventory is exhausted. Please contact Customer Service for current stock levels.



CARB COMPLIANT

Willow laminates meet or exceed California (CARB) air quality emission standards — the most stringent in the country — for composite wood products.













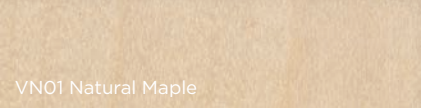
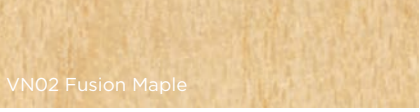
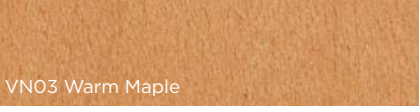
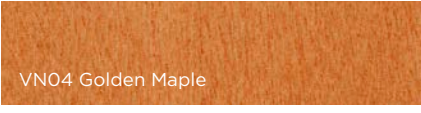
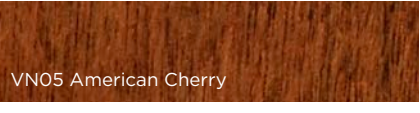
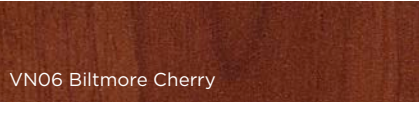

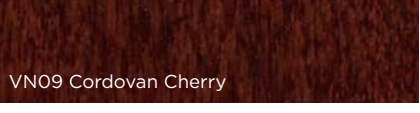
Order samples at www.friant.com

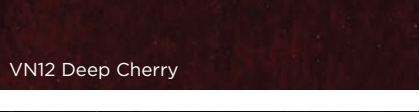
Please Note: Images are printed simulations and are not exact matches of finished product. Please request an actual sample from Friant or your sales consultant before specifying finishes.

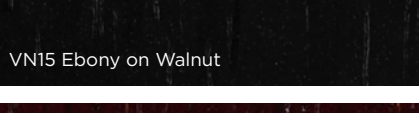

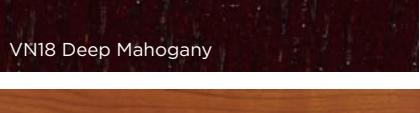
3 SELECT FINISHES: VENEER

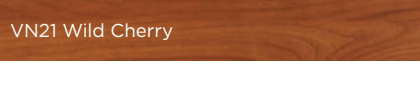
Table top finish choices: Veneer or Metal

VENEER Edge Groups 10 & 13

 <p>VN01 Natural Maple</p>	 <p>VN02 Fusion Maple</p>	 <p>VN03 Warm Maple</p>
 <p>VN04 Golden Maple</p>	 <p>VN05 American Cherry</p>	 <p>VN06 Biltmore Cherry</p>
 <p>VN07 Warm Cherry</p>	 <p>VN08 Axiom Cherry</p>	 <p>VN09 Cordovan Cherry</p>
 <p>VN10 Medium Cherry</p>	 <p>VN11 Espresso</p>	 <p>VN12 Deep Cherry</p>
 <p>VN13 Warm Walnut</p>	 <p>VN14 Natural Walnut</p>	 <p>VN15 Ebony on Walnut</p>
 <p>VN16 Light Mahogany</p>	 <p>VN17 Medium Mahogany</p>	 <p>VN18 Deep Mahogany</p>
 <p>VN19 Natural Oak</p>	 <p>VN20 Medium Oak</p>	 <p>VN21 Wild Cherry</p>
 <p>VNNS Custom*</p>		

METAL Edge Groups 11 & 14

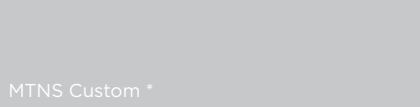
 <p>MT02 Clouds</p>	 <p>MT03 Coarse Grain</p>	 <p>MTNS Custom*</p>
--	---	---













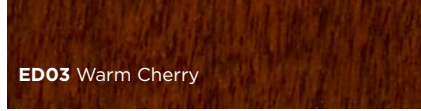

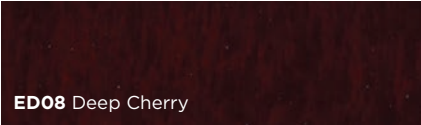

* For pricing on custom finishes, contact your Friant Sales Consultant.

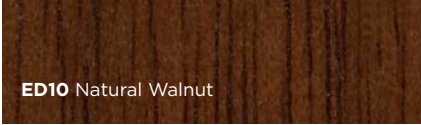
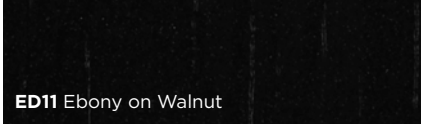
3 SELECT FINISHES: EDGE

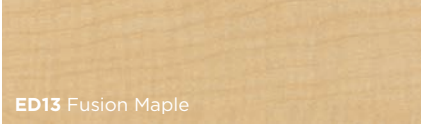
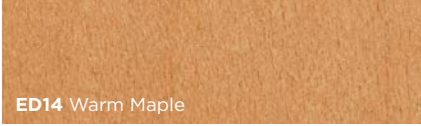

Table edge finish choices: solid wood

SOLID WOOD EDGE

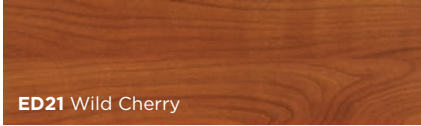
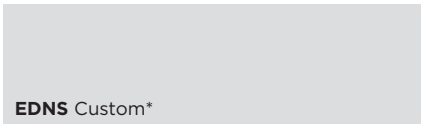
 <p>ED01 American Cherry</p>	 <p>ED02 Biltmore Cherry</p>	 <p>ED03 Warm Cherry</p>
 <p>ED04 Axiom Cherry</p>	 <p>ED05 Cordovan Cherry</p>	 <p>ED06 Medium Cherry</p>
 <p>ED07 Espresso</p>	 <p>ED08 Deep Cherry</p>	 <p>ED09 Warm Walnut</p>
 <p>ED10 Natural Walnut</p>	 <p>ED11 Ebony on Walnut</p>	 <p>ED12 Natural Maple</p>
 <p>ED13 Fusion Maple</p>	 <p>ED14 Warm Maple</p>	 <p>ED15 Golden Maple</p>
 <p>ED16 Light Mahogany</p>	 <p>ED17 Medium Mahogany</p>	 <p>ED18 Deep Mahogany</p>
 <p>ED19 Natural Oak</p>	 <p>ED20 Medium Oak</p>	 <p>ED21 Wild Cherry</p>
 <p>EDNS Custom*</p>		



Order samples at www.friant.com

Please Note: Images are printed simulations and are not exact matches of finished product. Please request an actual sample from Friant or your sales consultant before specifying finishes.

3 SELECT FINISHES: EDGE

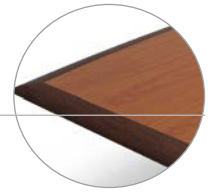

Table edge finish choices: Laminate and PVC.













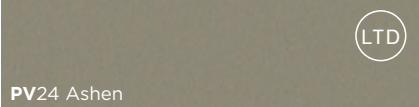



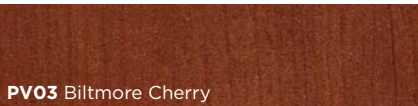

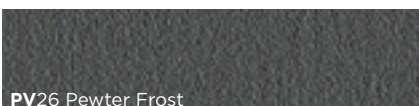
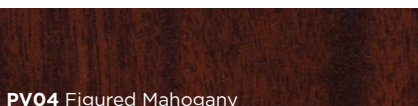

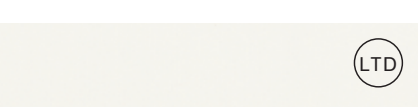

LAMINATE EDGE

<p>LE01 Fusion Maple</p>	<p>LE12 Walnut Heights</p>	<p>LE24 Ashen LTD</p>
<p>LE02 Wild Cherry</p>	<p>LE13 Licorice Groovz</p>	<p>LE25 Fog Grey</p>
<p>LE03 Biltmore Cherry</p>	<p>LE14 Driftwood</p>	<p>LE26 Pewter Frost</p>
<p>LE04 Figured Mahogany</p>	<p>LE15 Mochatini LTD</p>	<p>LE27 Weathered Ash</p>
<p>LE29 Windsor Mahogany LTD</p>	<p>LE16 Concrete Groovz</p>	<p>LE28 White Ash</p>
<p>LE07 Antique White LTD</p>	<p>LE18 Aria</p>	<p>LE08 Black/BU</p>
<p>LE09 Frosty White/CW</p>	<p>LE19 Silver Frost</p>	<p>LE05 Slate Grey (MT)</p>
<p>LE10 Cafelle</p>	<p>LE20 Shadow Frost</p>	<p>LE06 Pepperdust (LG)</p>
<p>LE11 River Cherry</p>	<p>LE23 Stromboli</p>	<p>LMNS Custom</p>

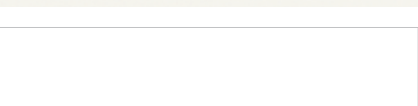
LTD Laminate is scheduled for discontinuation when inventory is exhausted. Please contact Customer Service for current stock levels.

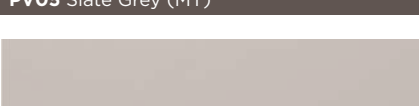

PVC EDGE

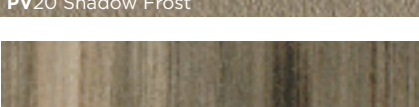
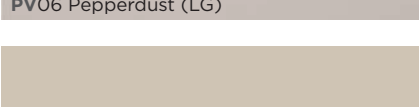
 PV01 Fusion Maple	 PV12 Walnut Heights	 PV24 Ashen
 PV02 Wild Cherry	 PV13 Licorice Groovz	 PV25 Fog Grey
 PV03 Biltmore Cherry	 PV14 Driftwood	 PV26 Pewter Frost
 PV04 Figured Mahogany	 PV15 Mochatini	 PV27 Weathered Ash
 PV29 Windsor Mahogany	 PV16 Concrete Groovz	 PV28 White Ash
 PV07 Antique White	 PV18 Aria	 PV08 Black/BU
 PV09 Frosty White/CW	 PV19 Silver Frost	 PV05 Slate Grey (MT)
 PV10 Cafelle	 PV20 Shadow Frost	 PV06 Pepperdust (LG)
 PV11 River Cherry	 PV23 Stromboli	 LMNS Custom

 Laminate is scheduled for discontinuation when inventory is exhausted. Please contact Customer Service for current stock levels.



Order samples at www.friant.com
Please Note: Images are printed simulations and are not exact matches of finished product. Please request an actual sample from Friant or your sales consultant before specifying finishes.

4 SELECT BASE OPTION

Select an inset finish and column finish. A standard Mesa table has a perforated metal base inset and metal columns available in Aluminum, Black or White finish.

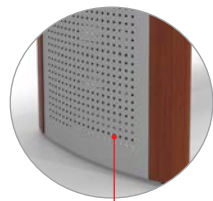

Inset Finishes

Veneer, laminate and metal insets available with additional cost — see upcharge table below.

Metals (Standard):

- MBST** Perforated Aluminum
- MBSB** Perforated Black
- MBSW** Perforated White

Insets with upcharge:

- MB01** Clouds
- MB04** Coarse Grain
- MBNS** Custom†

Veneers

- VBME** Match Edge
- VB01** American Cherry
- VB02** Biltmore Cherry
- VB03** Warm Cherry
- VB04** Axiom Cherry
- VB05** Cordovan Cherry
- VB06** Medium Cherry
- VB07** Espresso
- VB08** Deep Cherry
- VB09** Warm Walnut
- VB10** Natural Walnut
- VB11** Ebony on Walnut
- VB12** Natural Maple
- VB13** Fusion Maple
- VB14** Warm Maple
- VB15** Golden Maple
- VB16** Light Mahogany
- VB17** Medium Mahogany
- VB18** Deep Mahogany
- VB19** Natural Oak
- VB20** Medium Oak
- VB21** Wild Cherry
- VBNS** Custom†

Laminates

- LB01** Fusion Maple
- LB02** Wild Cherry
- LB03** Biltmore Cherry
- LB05** Figured Mahogany
- LB07** Antique White*
- LB08** Windsor Mahogany*
- LB09** Black
- LB29** Frosty White
- LB10** Cafelle
- LB11** River Cherry
- LB12** Walnut Heights
- LB13** Licorice Groovz
- LB14** Driftwood
- LB15** Mochatini*
- LB16** Concrete Groovz
- LB18** Aria
- LB19** Silver Frost
- LB20** Shadow Frost
- LB23** Stromboli
- LB24** Ashen*
- LB25** Fog Grey
- LB26** Pewter Frost
- LB27** Weathered Ash
- LB28** White Ash
- LB04** Slate Grey
- LB06** Pepperdust
- LBNS** Custom†

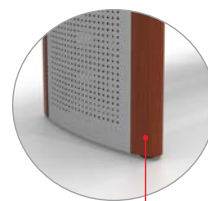

Column Finishes

Veneer columns available with additional cost — see upcharge table below.

Metals (Standard):

- VCST** Aluminum
- VCSB** Black
- VCSW** White

Columns with upcharge:

Veneers

- VC01** American Cherry
- VC02** Biltmore Cherry
- VC03** Warm Cherry
- VC04** Axiom Cherry
- VC05** Cordovan Cherry
- VC06** Medium Cherry
- VC07** Espresso
- VC08** Deep Cherry
- VC09** Warm Walnut
- VC10** Natural Walnut
- VC11** Ebony on Walnut
- VC12** Natural Maple
- VC13** Fusion Maple
- VC14** Warm Maple
- VC15** Golden Maple
- VC16** Light Mahogany
- VC17** Medium Mahogany
- VC18** Deep Mahogany
- VC19** Natural Oak
- VC20** Medium Oak
- VC21** Wild Cherry
- VCNS** Custom†

Base Option Upcharges

Table length	Veneer Inset	Metal Inset	Laminate Inset	Veneer columns
8', 9', 10'	\$2,526	\$2,753	\$1,516	\$2,526
11', 12', 14', 16	\$3,790	\$4,130	\$2,274	\$3,790
18', 20', 22'	\$5,052	\$5,507	\$3,031	\$5,052

†For pricing on custom finishes, contact your Friant Sales Consultant.

*Laminate is scheduled for discontinuation when inventory is exhausted. Please contact Customer Service for current stock levels.

SELECT BASE OPTION CONTINUED

STANDARD MESA BASE: Matching inset and columns, 3 color choices.



INSET: Perforated metal
 MBST Aluminum
 MBSB Black
 MBSW White

COLUMNS: Metal
 VCST Aluminum
 VCSB Black
 VCSW White

Specify MBST/VCST, MBSB/VCSB, or MBSW/VCSW

ADDITIONAL BASE DESIGNS: Please see upcharge chart, below.



INSET: Metal
COLUMNS: Aluminum



INSET: Metal
COLUMNS: Veneer



INSET: Laminate
COLUMNS: Aluminum



INSET: Perforated Aluminum
COLUMNS: Veneer



INSET:
 Veneer

COLUMNS:
 Aluminum

SPECIFICATIONS
CONFERENCE
MESA

NUMBER OF DOORS, BASES AND SEAMS

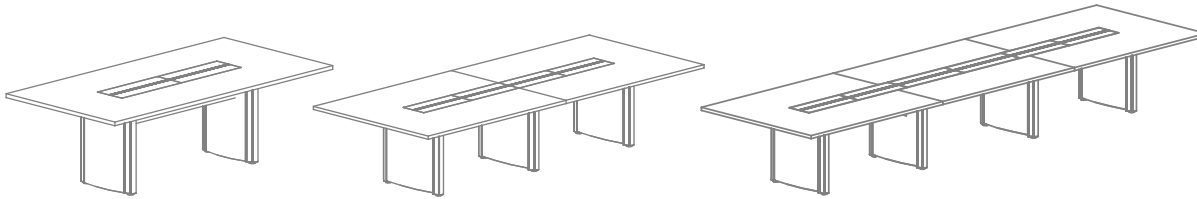
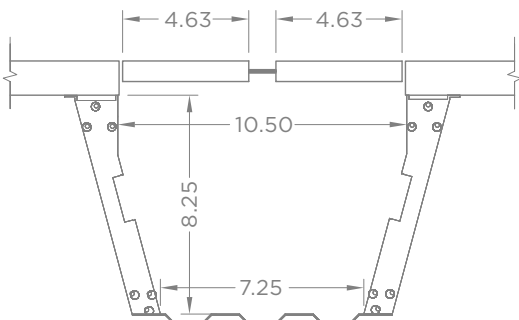

Table Length	8 ft	9 ft	10 ft	11 ft	12 ft	14 ft	16 ft	18 ft	20 ft	22 ft
Doors	4	4	4	4	8	8	8	12	12	12
Bases	2	2	2	3	3	3	3	4	4	4
Seams	0	1	1	1	1	1	2	2	2	2

TROUGH DIMENSIONS



INSIDE BASE CLEARANCE

Base for 48" Wide Top

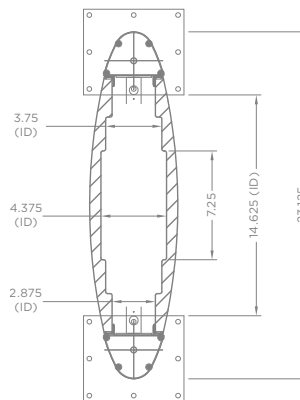

Base for 60" Wide Top

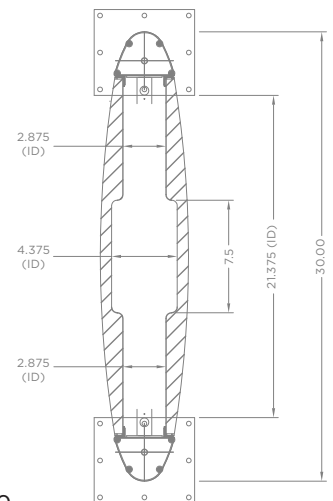

Drawings with base locations for core drilling are available at www.friant.com

TERMS & CONDITIONS

PRICES

All prices are F.O.B. point. We reserve the right to change prices without prior notice.

ORDERING

Purchase Orders should be sent to Friant & Associates, LLC at orders@friant.com, or faxed to (510) 535-6895. If your specifications were created with CAP, GIZA, or Project Matrix please send the worksheet (SP4) with your Purchase Order.

TERMS

Net 30 days from date of invoice with established terms. Invoices are delinquent if not paid (30) days from date of invoice. In the event timely payment is not made, interest will be charged at the rate of 1.5% per month on delinquent accounts. Buyers will also be liable for normal collection costs and attorney fees.

ORDERS

Orders are only accepted by issuance of our formal acknowledgment, and are subject to the terms set forth herein and on our order acknowledgment. It is the responsibility of the buyer to review our acknowledgment for accuracy.

LEAD TIME

Lead times are subject to availability.

ORDER CHANGES AND CANCELLATIONS

Our order confirmation is final and binding. Any order change or cancellation is subject to our ability to conform. For the most up to date information, always review the order change/cancellation policy online. Allowable changes within the posted policy must be made in writing.

RETURNS

No merchandise may be returned without our written consent and shipping instructions, and are subject to a 35% restocking fee. Unauthorized returns will not be accepted and will be returned freight collect. All packages are labeled with contents, and it is the customer's responsibility to check box labels against the packing list for accuracy before opening. If correctly labeled and undamaged product is removed from its original packaging, Friant will not accept its return.

CLAIMS

We are not responsible for damage suffered in transit. Merchandise should be inspected for possible freight damage upon delivery. Claims for damage or shortages should be filed by the consignee with the carrier within 5 days of delivery. You are also protected for "concealed damage" if you file claim with the carrier within 5 days of delivery. All claims against Friant for defects, errors or shortages must be made by Buyer in writing within 10 days after delivery. Failure to make such a claim shall constitute full acceptance. All claims must be pre-approved and with a P.O. issued to Friant before reimbursement and/or reinstallation will be granted.

SHIPPING

Friant generally palletizes, boxes and/or shrink wraps its products. If Buyer requests additional packaging or special shipping, extra charges will apply. Buyer obtains title to products and assumes the risk of loss for them upon shipment from Friant's plant.

PARTIAL SHIPMENTS

We will make every attempt to ship orders complete and on schedule. However, we reserve the right to make partial shipments as merchandise is ready. Invoices covering these partial shipments are to be paid as they become due.

SHIPPING AND PREPAID FREIGHT

Unless otherwise instructed, we reserve the option to ship by what is, in our opinion, the best possible way. Upon request, we will prepay and add freight for accounts with established credit. Please see our web site for estimated freight times.

DELIVERY

We are not liable for delay or failure of delivery due to strikes and/or differences with workmen, war, riot, fire, compliance with government regulations, acts of nature, failure or delays of sources of supply, or any other causes beyond our control.

STORAGE

If buyer cannot accept delivery when merchandise is ready, we reserve the right to transfer goods to storage. Costs of transfer and storage will be charged to the buyer's account, and we will deem such transfer as constituting shipment for all purposes, including invoicing, as of the date the transfer is made.

CONSTRUCTION - SPECIFICATIONS

All items are produced to price list specifications unless otherwise advised. All dimensions shown are approximate. Manufacturer reserves the right to make modifications and/or improvements without prior notice.

COMPLIANCE WITH LAW

Purchaser is solely responsible for compliance with all applicable Federal, State and Local laws, ordinances, regulations, rules and standards relating to the installation, maintenance, use and operation of products.

TERMS & CONDITIONS

CALIFORNIA PROP 65 WARNING

Products in this catalog can expose you to chemicals including wood dust, which is known to the State of California to cause cancer or birth defects or other reproductive harm. For more information go to <https://www.p65warnings.ca.gov/products/furniture-products>.”

CARB

Friant products are CARB 93120 compliant for formaldehyde (phase 2)

TSCA TITLE VI

Friant products are TSCA Title VI Compliant

MAS

Accredited Compliance Designation - ANSI/BIFMA x7.1 & e3-2014 7.6.1, 7.6.2, 7.6.3

California Dept. Of Public Health Standard Method v1.2

Conforms With: LEED v4

Criteria of MAS Certified Green® Program

CARE AND MAINTENANCE

Friant & Associates' finish provides excellent stain and mar resistance. Care should be exercised when cleaning. The following precautions will help keep the product looking new:

- Dust all surfaces on a regular basis with a soft damp cloth. Do not use spray polishes – especially those containing silicone.
- Lift all objects from the surface when moving – never drag objects across the surface.
- Metal objects should be kept from contacting the surface.

TERMS & CONDITIONS

LUNE AND SCOPE RIGHTS AND WARRANTIES – LIMITED LIFETIME WARRANTY

This warranty is given to the initial purchaser and is valid from the date of purchase, for as long as the initial purchaser owns the product. This warranty covers defects in material and craftsmanship found during normal usage of the product during the warranty period. Normal usage is defined by 8 hour shifts in the product's intended application and in an indoor environment that conforms to the ANSI/ASHRAE Standard 55: Thermal Environmental Conditions for Human Occupancy (relating to air temperature, mean radiant temperature, air velocity, clothing insulation, metabolic rate, and humidity). Friant's warranty does not cover usage other than normal usage as defined in the previous sentence. If the product is defective, and if written notice of the defect is given to Friant & Associates within the applicable warranty period, Friant & Associates, at its option, will either repair or replace the defective product with a comparable component or product. This warranty applies to all products except as noted below.

MESA PRODUCT WARRANTY - 3 YEARS

This warranty is given to the initial purchaser and is valid from the date of purchase, for 3 years. This warranty covers defects in material and craftsmanship found during normal usage of the product during the warranty period. Normal usage is defined by 8 hour shifts in the product's intended application and in an indoor environment that conforms to the ANSI/ASHRAE Standard 55: Thermal Environmental Conditions for Human Occupancy (relating to air temperature, mean radiant temperature, air velocity, clothing insulation, metabolic rate, and humidity). Friant's warranty does not cover usage other than normal usage as defined in the previous sentence. If the product is defective, and if written notice of the defect is given to Friant & Associates within the applicable warranty period, Friant & Associates, at its option, will either repair or replace the defective product with a comparable component or product. This warranty applies to all products except as noted below.

WARRANTY EXCEPTIONS:

- Natural variations in wood grain, figure or the presence of character marks
- Matching of colors, grains, textures
- Changes in surface finishes due to aging or exposure to light
- Damage, marking or staining of surfaces due to contact with rubber or similar compounds
- Damage from sharp objects or imprinting from writing instruments, computer equipment or prolonged exposure to fluids or sun
- Checking or delaminating due to changes in temperature or improper care or storage
- Damage caused by misuse or improper care

High wear parts, such as wood veneer, fabrics, laminates, and other covering material/finishes, foam, glides, etc. are warranted for one (1) year. This warranty does not apply to damage caused by a carrier, alteration to the product not expressly authorized by Friant & Associates, nor to product considered to be of a consumable nature such as bulbs, light ballasts, etc. It also does not apply to "Customer's Own Material" (i.e. material specified by the customer that is not a standard Friant & Associates offering) used in the manufacture of Friant & Associates products.

Friant & Associates does not guarantee the matching of colors, grain or texture, except to within commercially acceptable standards. This includes normal variations between dye lots (fabrics).

A product will not be considered defective, and Friant & Associates will not be obligated to replace it, if it is not installed in a proper manner (i.e., product not leveled, not secured properly, etc.) or if it is not used in a manner and/or in an environment that constitutes normal usage, as defined above.

Except as noted above, Friant & Associates makes no express or implied warranties as to any product, and in particular makes no warranty of fitness for any particular use. At Friant & Associates' option, product repair and/or replacement are the customer's exclusive remedy for any and all product defects.

Friant & Associates shall not be liable for consequential, economic or incidental damages arising from any product defect.